

Color CCTV Cameras Operating Instructions

Model No. **WV-CP240**
WV-CP242
WV-CP244

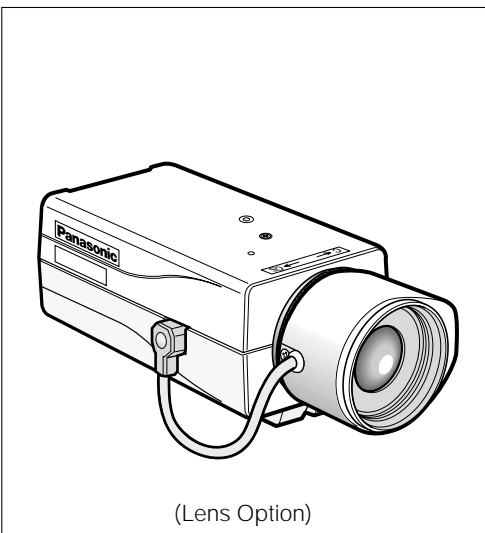

(Lens Option)

Before attempting to connect or operate this product,
please read these instructions carefully and save this manual for future use.

N0301-0

V8QA5733AN

Printed in Japan
© 19

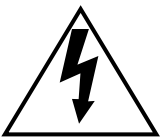
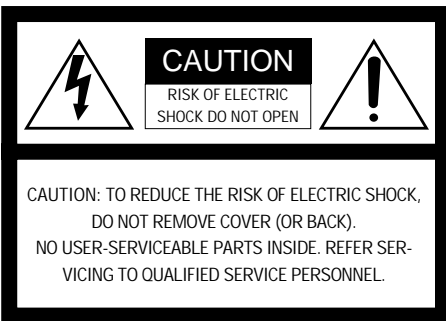

SA 1965

The lightning flash with arrowhead symbol, within an equilateral triangle, is intended to alert the user to the presence of uninsulated "dangerous voltage" within the product's enclosure that may be of sufficient magnitude to constitute a risk of electric shock to persons.



SA 1966

The exclamation point within an equilateral triangle is intended to alert the user to the presence of important operating and maintenance (servicing) instructions in the literature accompanying the appliance.

WARNING:

To reduce the risk of fire or electric shock, do not expose this appliance to rain or moisture.

PREFACE

Panasonic's WV-CP240/CP242/CP244 series digital signal processing color CCD cameras introduce a new level of high picture quality and high resolution through the use of a 1/3-inch interline

transfer CCD image sensor having 768 horizontal pixels (picture elements), and digital signal processing LSI's. This model offers cutting-edge technology for advanced video surveillance.

FEATURES

- The following functions are built in.
 - Auto Light Control (ALC)/Electronic Light Control (ELC)
 - Automatic Gain Control (AGC) +15 dB and Automatic Tracing White Balance (ATW)
 - Camera synchronization mode selectable between internal (INT), Line-locked (LL) for WV-CP240 and WV-CP244 and Multiplexed Vertical Drive (VD2).
- Minimum illumination of 0.6 lx (0.06 foot-candle) at F0.75 (equivalent to 2.0 lx (0.2 foot-candle) at F1.4)
- Signal-to-noise ratio of 50 dB (Equivalent to AGC Off)
- Horizontal resolution of 480 lines
- Auto iris lens control selectable between video signal and DC power supply.

PRECAUTIONS

- Do not attempt to disassemble the camera.**
To prevent electric shock, do not remove screws or covers.
There are no user serviceable parts inside. Ask a qualified service person for servicing.
- Handle the camera with care.**
Do not abuse the camera. Avoid striking, shaking, etc. The camera could be damaged by improper handling or storage.
- Do not expose the camera to rain or moisture, or try to operate it in wet areas.**
Turn the power off immediately and ask a qualified service person for servicing. Moisture can damage the camera and also create the danger of electric shock.
- Do not use strong or abrasive detergents when cleaning the camera body.**
Use a dry cloth to clean the camera when dirty.
In case the dirt is hard to remove, use a mild detergent and wipe gently. Afterwards, wipe off the remained part of the detergent in it with a dry cloth.
- Clean the CCD faceplate with care.**
Do not clean the CCD with strong or abrasive detergents. Use lens tissue or a cotton tipped applicator and ethanol.
- Never face the camera towards the sun.**
Do not aim the camera at bright objects.

Whether the camera is in use or not, never aim it at the sun or other extremely bright objects. Otherwise, blooming or smear may be caused.

7. Do not operate the camera beyond the specified temperature, humidity or power source ratings.

Use the camera under conditions where temperature is between -10°C - $+50^{\circ}\text{C}$ (14°F - 122°F), and humidity is below 90 %. The input power source is 120 V AC 60 Hz for WV-CP240, 12 V DC for WV-CP242, and 24 V AC 60 Hz for WV-CP244.

Caution:

To prevent fire or electric shock hazard, use a UL listed cable (VW-1, style 1007) for the DC 12 V or AC 24 V Input Terminal.

MAJOR OPERATING CONTROLS AND THEIR FUNCTIONS

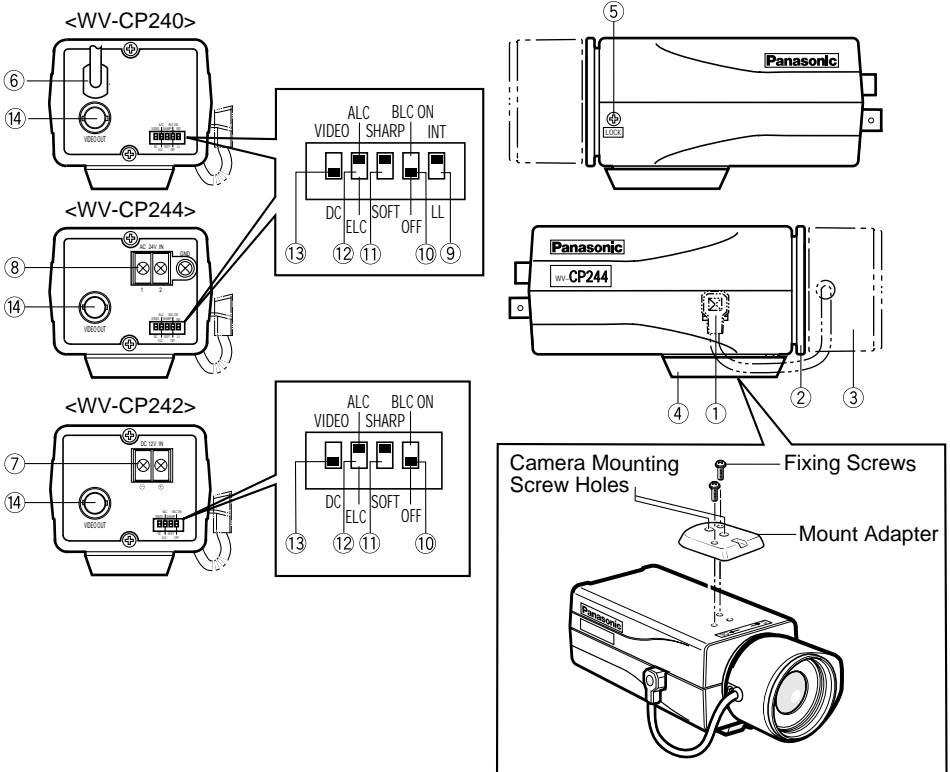

- ① **Auto Iris Lens Connector**
Supplies power and control signals to an auto iris lens (not supplied).
- ② **Flange-back Adjusting Ring**
This ring adjusts the back-focal distance or picture focus. Rotate this ring clockwise for a C-mount lens or counterclockwise for a CS-mount lens.
- ③ **Lens (option)**
- ④ **Mount Adapter**
The camera mounting screw hole is for mounting the camera onto a mounting bracket. The camera is originally designed to be mounted from the bottom, however, a top-mounting type is also available. To mount from the top, remove the mount adapter from the bottom of the camera by removing two fixing screws. Attach the mount adapter to the top as shown in the diagram, then mount the camera on the mounting bracket. Make sure that two original screws are used when mounting the mount adapter; longer type screws may damage inner components, too shorter type screws may cause the camera drop.
- ⑤ **Focus Fixing Screw**
- ⑥ **Power Cord (only for WV-CP240)**
Connect this power cord to an electrical outlet of 120 V AC 60 Hz.
- ⑦ **DC 12 V Input Terminal [DC 12V IN (only for WV-CP242)]**
This terminal is for connecting the 12 V DC power supply cord.
- ⑧ **AC 24 V Input Terminal [AC 24V IN (only for WV-CP244)]**
This terminal is for connecting the 24 V AC 60Hz power supply cord.
- ⑨ **Synchronization Mode Selector [INT, LL (only for WV-CP240 and WV-CP244)]**
Selects the camera synchronization mode as either internal sync mode (INT) or line-lock mode (LL).
INT: Sets to internal 2:1 interlace.
LL: Sets to Line-lock mode.
- ⑩ **Back Light Compensation Mode Selector (BLC ON, OFF)**
Lets you select the mode according to the position of the object and light conditions on the screen.
ON: Select this mode when a strong light such as a spotlight is in the background.
OFF: Normal picture.
- ⑪ **Detail/Aperture Level Selector (SHARP, SOFT)**
The detail/aperture level can be selected with this selector. Set it to the desired position while observing the picture on the monitor.
SHARP: Normal position.
SOFT: Select this position when a Quad System is connected to this camera.
- ⑫ **Automatic Light Control/Electronic Light Control Selector (ALC, ELC)**
Lets you select the mode according to the lens type used.
ALC: Select this mode when an auto iris lens (ALC lens) is used with this camera.
ELC: Select this mode when a fixed iris lens or manual iris lens is used with this camera.
- ⑬ **Lens Drive Signal Selector (VIDEO, DC)**
Lets you select the mode according to the type of auto iris lens drive signal to be supplied to the lens from the auto iris lens connector.
VIDEO: Select this mode if you are using a auto iris lens that requires a video drive signal.
DC: Select this mode if you are using a auto iris lens that requires a DC drive signal.
- ⑭ **Video Output Connector (VIDEO OUT)**
This connector is for connecting with the VIDEO IN connector of the video monitor. Whenever the multiplexed vertical drive (VD2) signal is supplied to this connector, the camera synchronization mode is automatically set to Vertical Drive.

Cautions:

- Connect to 12 V DC (10.5 V-16 V) or 24 V AC (19.5 V-28 V) class 2 power supply only. Make sure to connect the grounding lead to the GND terminal when the power is supplied from a 24 V AC power source.
- To prevent fire or electric shock hazard, use a UL listed cable (VW-1, style 1007) for the DC 12 V or AC 24 V Input Terminal.

CONNECTIONS

A. WV-CP240 (120V AC 60Hz)

Connect the power cord to an electrical outlet of 120V AC 60Hz.

B. WV-CP242 (12V DC)

Connect the power cord to the DC 12V IN terminal on the rear panel of the WV-CP242.

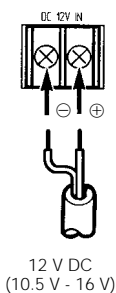

Resistance of copper wire [at 20°C (68°F)]

Copper wire size (AWG)	#24 (0.22mm ²)	#22 (0.33mm ²)	#20 (0.52mm ²)	#18 (0.83mm ²)
Resistance Ω/m	0.078	0.050	0.03	0.018
Resistance Ω/ft	0.026	0.017	0.010	0.006

- Calculation of maximum cable length between camera and power supply :

$$10.5V DC \leq V_A - (R \times 0.42 \times L) \leq 16V DC$$

L : Cable length (meters)

R : Resistance of copper wire (Ω/meter)

V_A : DC output voltage of power supply unit

$$L \text{ standard} = \frac{V_A - 12}{0.42 \times R} \quad (\text{meters})$$

$$L \text{ minimum} = \frac{V_A - 16}{0.42 \times R} \quad (\text{meters})$$

$$L \text{ maximum} = \frac{V_A - 10.5}{0.42 \times R} \quad (\text{meters})$$

C. WV-CP244 (24V AC 60Hz)

Connect the power cable to the AC 24 V IN terminal on the rear panel of the WV-CP244.

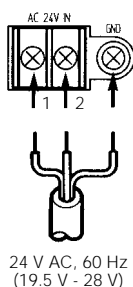

Recommended wire gauge sizes for 24 V AC line

Copper wire size (AWG)	#24 (0.22mm ²)	#22 (0.33mm ²)	#20 (0.52mm ²)	#18 (0.83mm ²)	
Length of Cable (Approx.)	(m)	95	150	255	425
	(ft)	314	495	842	1 403

Caution:

To prevent fire or electric shock hazard, use a UL listed cable (VW-1, style 1007) for the DC 12 V or AC 24 V Input Terminal.

Video Cable

1. It is recommended to use a monitor whose resolution is at least equal to that of the camera.
2. The maximum extensible coaxial cable length between the camera and the monitor is shown below.

Type of coaxial cable	RG-59/U (3C-2V)	RG-6/U (5C-2V)	RG-11/U (7C-2V)	RG-15/U (10C-2V)
Recommended maximum cable length	(m)	250	500	800
	(ft)	825	1 650	2 640

Installation of Auto Iris Lens Connector

Install the lens connector (YFE4191J100) when using a video drive ALC lens.

The installation should be made by qualified service personnel or system installers.

Cut the iris control cable at the edge of the lens connector to remove the existing lens connector and then remove the outer cable cover of the supplied connector as shown in the diagram.

The pin assignment of the lens connector is as follows:

- Pin 1: Power source; +9 V DC, 50 mA max.
- Pin 2: Not used
- Pin 3: Video signal; 1.3 V[p-p]/40 kΩ
- Pin 4: Shield, ground

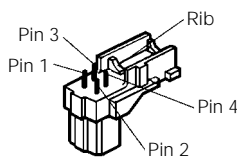

Solder the lens cable to the pins of the supplied connector.

Mounting the Lens

Caution:

Before you mount the lens, loosen the screw on the side of the camera, and rotate the flange-back adjusting ring clockwise until it stops. If the ring is not at the end, the inner lens or CCD image sensor may be damaged.

- ① Mount the lens by turning it clockwise on the lens mount of the camera.
- ② Connect the lens cable to the auto iris lens connector on the side of the camera.

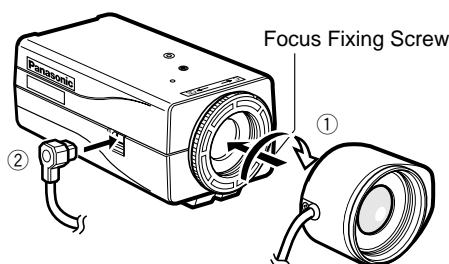

Caution for Mounting the Lens

The lens mount should be a C-mount or CS-mount (1"-32UN) and the lens weight should be less than 450 g (0.99 lbs). If the lens is heavier, both the lens and camera should be secured by using the supporter.

The protrusion at the rear of the lens should be as shown in the diagram.

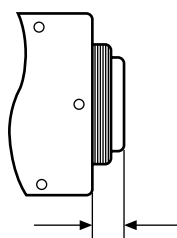

C-mount: Less than 13 mm (1/2")
CS-mount: Less than 8 mm (5/16")

FOCUS OR FLANGE-BACK ADJUSTMENT

The following adjustment should be made by qualified service personnel or system installers.

- ① Loosen the screw on the side of the camera.

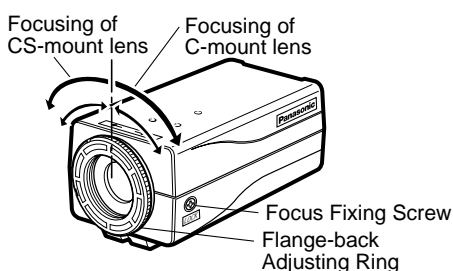

- ② Turn the flange-back adjusting ring to the desired position.

Caution: When the C-mount lens is mounted, do not rotate the ring counterclockwise by force after it stops. If the ring is rotated by force, the inner lens or CCD image sensor may be damaged.

- ③ Tighten the screw on the side of the camera.

Caution: Tightening the screw by force will cause damage to the screw or deviation of focus.

SPECIFICATIONS

Pick-up Device:	768 (H) x 494 (V) pixels, Interline Transfer CCD
Scanning Area:	4.92 (H) x 3.70 (V) mm (Equivalent to scanning area of 1/3" pick-up tube)
Synchronization:	Internal, Line-locked or Multiplexed vertical drive (VD2), selectable
Scanning System:	2 : 1 interlace
Scanning:	525 lines / 60 fields / 30 frames
Horizontal:	15.734 kHz
Vertical:	59.94 Hz
Horizontal Resolution:	480 lines
Video Output:	1.0 V[p-p] NTSC composite 75 Ω / BNC connector
Signal-to-Noise Ratio:	50 dB (Equivalent to AGC Off, weight On)
Electronic Light Control:	Equivalent to continuous variable shutter speed between 1/60 s and 1/15 000 s
Minimum Illumination:	0.6 lx (0.06 foot-candle) at F0.75 [equivalent to 2.0 lx (0.2 foot-candle) at F1.4] AGC On
Detail:	SHARP or SOFT, selectable
Lens Mount:	C-mount or CS-mount, selectable
Ambient Operating Temperature:	-10°C - +50°C (14°F - 122°F)
Ambient Operating Humidity:	Less than 90 %
Power Source and	WV-CP240: 120 V AC 60 Hz, 3.6 W
Power Consumption:	WV-CP242: 12 V DC, 270 mA
	WV-CP244: 24 V AC 60 Hz, 3.3 W
Dimensions (without lens):	67 mm (W) x 65 mm (H) x 123 mm (D) 2-5/8" (W) x 2-9/16" (H) x 4-13/16" (D)
Weights (without lens):	WV-CP240: 0.48 kg (1.06 lbs) WV-CP242: 0.3 kg (0.66 lbs) WV-CP244: 0.33 kg (0.73 lbs)

Weights and dimensions indicated are approximate.
Specifications are subject to change without notice.

STANDARD ACCESSORIES

Body Cap.....	1 pc.
ALC Lens Connector (YFE4191J100).....	1 pc.

OPTIONAL ACCESSORIES

Lenses: WV-LA2R8C3B, WV-LA4R5C3B, WV-LA9C3B, WV-LA210C3, WV-LA408C3, WV-LA908C3, WV-LZ61/10, WV-LZ62/2, WV-LZ62/8, WV-LF4R5C3A, WV-LF9C3A, WV-LFY3C3, WV-LFY45C3, WV-LFY9C3

Panasonic Security and Digital Imaging Company

A Division of Matsushita Electric Corporation of America

Executive Office: One Panasonic Way 3E-7, Secaucus, New Jersey 07094

Regional Offices:

Northeast: One Panasonic Way, Secaucus, NJ 07094 (201) 348-7303

Southern: 1225 Northbrook Parkway, Suite 1-160, Suwanee, GA 30024 (770) 338-6838

Midwest: 1707 North Randall Road, Elgin, IL 60123 (847) 468-5211

Western: 6550 Katella Ave., Cypress, CA 90630 (714) 373-7840

Panasonic Canada Inc.

5770 Ambler Drive, Mississauga,
Ontario, L4W 2T3 Canada (905)624-5010

Panasonic Sales Company

Division of Matsushita Electric of Puerto Rico Inc.

Ave. 65 de Infanteria. Km. 9.5
San Gabriel Industrial Park, Carolina,
Puerto Rico 00985 (809)750-4300